

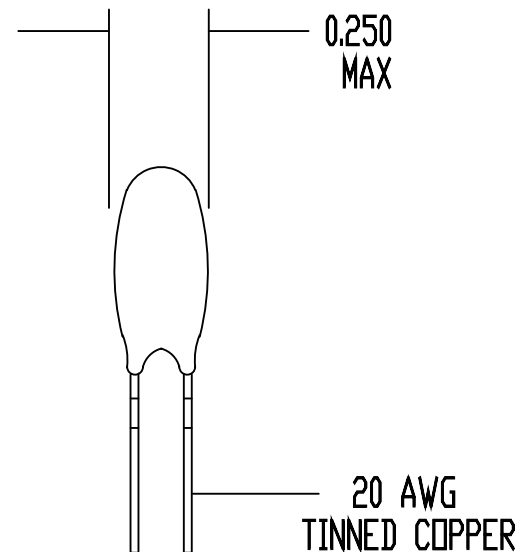

REV	DATE	ECD#
A	03/31/95	1342

DRAWING NOT TO SCALE  
ALL DIMENSIONS IN INCHES

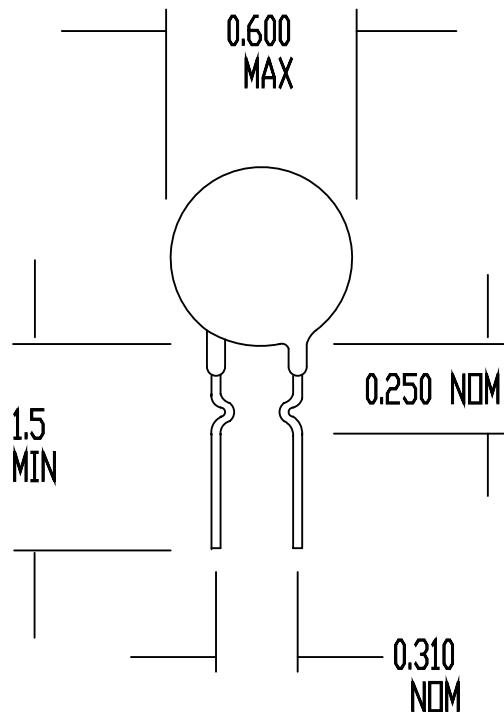

**SPECIFICATIONS:**

RESISTANCE AT 25 DEG C = 5 OHMS +/- 15%  
 MAX CONTINUOUS CURRENT ( $I_{max}$ ) = 7 AMPS  
 RESISTANCE AT  $I_{max}$  = 0.07 OHMS NOMINAL  
 MAX VOLTAGE RATING = 265 VAC (RMS)  
 MAX SURGE RATING = 40 JOULES  
 ENCAPSULATION = SILICONE RESIN  
 MARKING = OPTIONAL  
 LEADS = RODAN P/N STL-209-42

DRAWN BY D. NGUYEN		 <b>Circuit Protection Thermistors</b>
DATE 09/25/90	ORIG. F. TISED	
REV A	APP	<b>SURGE-GARD INRUSH CURRENT LIMITER</b>
SHEET 1 OF 1		SG311